

**JBX1-08 - IP40** (8 x Ø 0.7mm)

**Dimensions** (For mated connector lengths see page 141)

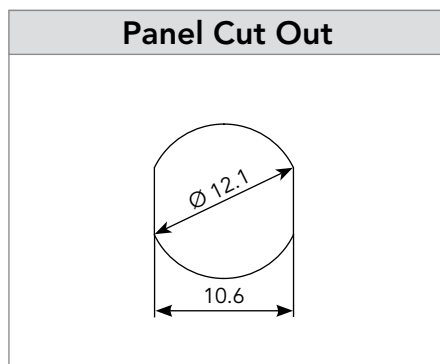
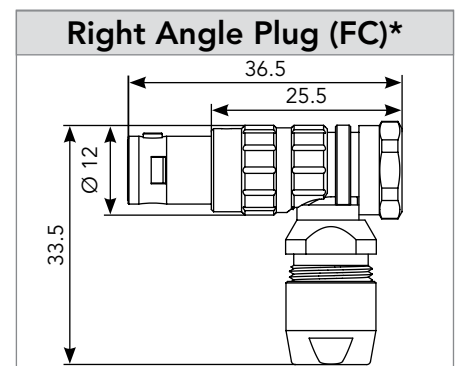
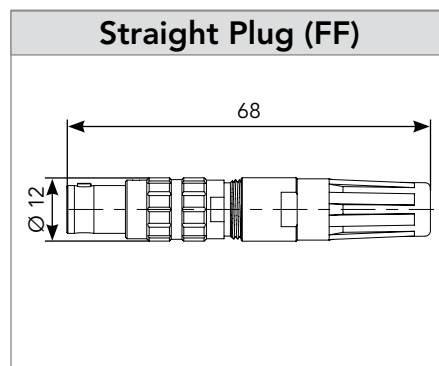
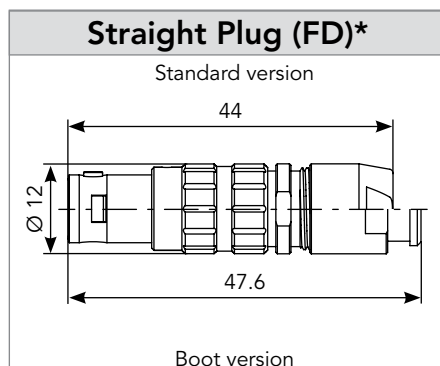
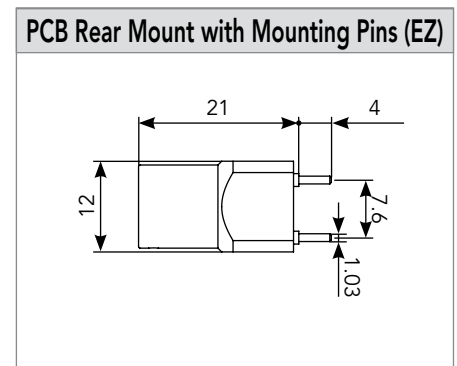
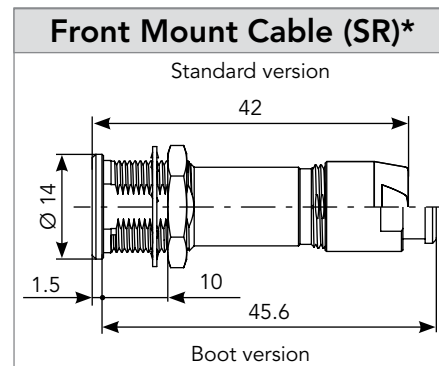
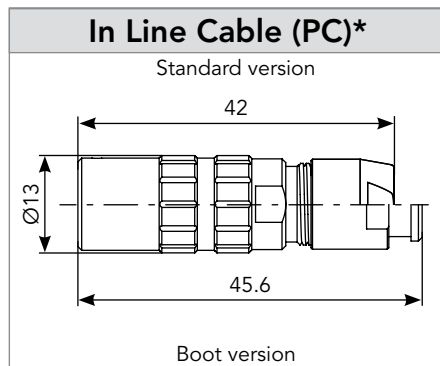
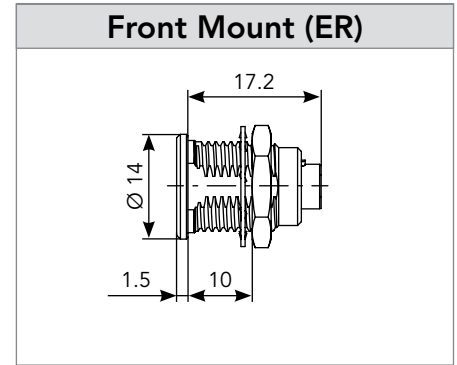
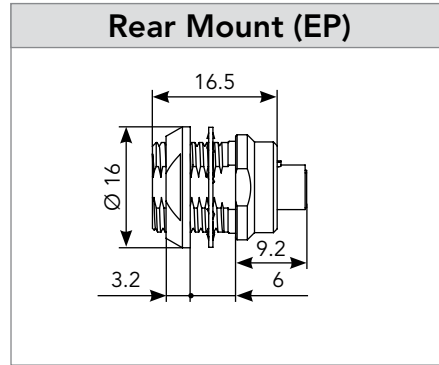
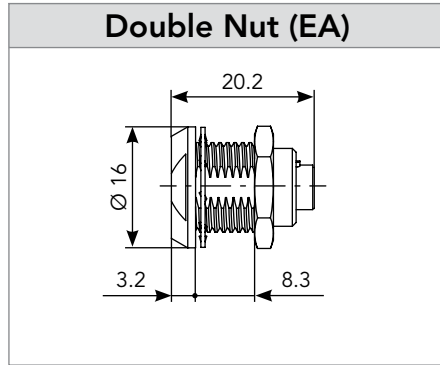

Note: all dimensions are in mm